

Thinking of you

 **Electrolux**

User Manual

Washing Machine

EWG 14440 W



We were thinking of you
when we made this product

Welcome to the world of Electrolux

Thank you for choosing a first class product from Electrolux, which hopefully will provide you with lots of pleasure in the future. The Electrolux ambition is to offer a wide variety of quality products that make your life more comfortable. You find some examples on the cover in this manual. Please take a few minutes to study this manual so that you can take advantage of the benefits of your new machine. We promise that it will provide a superior User Experience delivering Ease-of-Mind. Good luck!

Contents

Safety information.....5

Product description7

Control panel8

Use.....9

Washing hints17

International wash code symbol20

Washing programme21-22

Programme information23

Care and cleaning24

Something not working.....27

Technical data31

Consumption values32

Installation33

Built-in39

Environment concerns42

Guarantee conditions43

Customer service centres46

The following symbols are used in this manual:



Important information concerning your personal safety and information on how to avoid damaging the appliance.



General information and tips



Environmental information

Safety Information



In the interest of your safety and to ensure the correct use, before installing and first using the appliance, read this user manual carefully, including its hints and warnings. To avoid unnecessary mistakes and accidents, it is important to ensure that all people using the appliance are thoroughly familiar with its operation and safety features. Save these instructions and make sure that they remain with the appliance if it is moved or sold, so that everyone using it through its life will be properly informed on appliance use and safety.

General safety

- It is dangerous to alter the specifications or attempt to modify this product in any way.
- During high temperature wash programmes the door glass may get hot. Do not touch it!
- Make sure that small pets do not climb into the drum. To avoid this, please check into the drum before using.
- Any objects such as coins, safety pins, nails, screws, stones or any other hard, sharp material can cause extensive damage and must not be placed into the machine.
- Only use the advised quantities of fabric softener and detergent. Damage to the fabric can ensue if you over-fill. Refer to the manufacturer's recommendations of quantities.
- Wash small items such as socks, laces, washable belts etc in a washing bag or pillow case as it is possible for such items to slip down between the tub and the inner drum.
- Do not use your washing machine to wash articles with whalebones, material without hems or torn material.
- Always unplug the appliance and turn off the water supply after use, clean and maintenance.
- Under no circumstances should you attempt to repair the machine yourself. Repairs carried out by inexperienced persons may cause injury or serious malfunctioning. Contact your local Service Centre. Always insist on genuine spare parts.

Installation

- This appliance is heavy. Care should be taken when moving it.
- When unpacking the appliance, check that it is not damaged. If in doubt, do not use it and contact the Service Centre.
- All packing and transit bolts must be removed before use. Serious damage can occur to the product and to property if this is not adhered to. See relevant section in the user manual.
- After having installed the appliance, check that it is not standing on the inlet and drain hose and the worktop is not pressing the electrical supply cable.
- If the machine is situated on a carpeted floor, please adjust the feet in order to allow air to circulate freely
- Always be sure, that there is no water leakage from hoses and their connections after the installation.

6 safety information electrolux

- If the appliance is installed in a location subject to frost, please read the “**dangers of freezing**” chapter.
- Any plumbing work required to install this appliance should be carried out by a qualified plumber or competent person.
- Any electrical work required to install this appliance should be carried out by a qualified electrician or competent person.

Use

- This appliance is designed for domestic use. It must not be used for purposes other than those for which it was designed.
- Only wash fabrics which are designed to be machine washed. Follow the instructions on each garment label.
- Do not overload the appliance. See the relevant section in the user manual.
- Before washing, ensure that all pockets are empty and buttons and zips are fastened. Avoid washing frayed or torn articles and treat stains such as paint, ink, rust, and grass before washing. Underwired bras must NOT be machine washed.
- Garments which have been in contact with volatile petroleum products should not be machine washed. If volatile cleaning fluids are used, care should be taken to ensure that the fluid is removed from the garment before placing in the machine.
- Never pull the power supply cable to remove the plug from the socket; always take hold of the plug itself.

- Never use the washing machine if the power supply cable, the control panel, the working surface or the base are damaged so that the inside of the washing machine is accessible.

Child safety

- This washing machine is not intended for use by young children or infirm persons without supervision.
- Young children should be supervised to ensure that they do not play with the appliance.
- The packaging components (e.g. plastic film, polystyrene) can be dangerous to children - danger of suffocation! Keep them out of children's reach
- Keep all detergents in a safe place out of children's reach.
- Make sure that children or pets do not climb into the drum. To avoid this the machine incorporates special feature. To activate this device, rotate the button (without pressing it) inside the door clockwise until the groove is horizontal. If necessary use a coin.

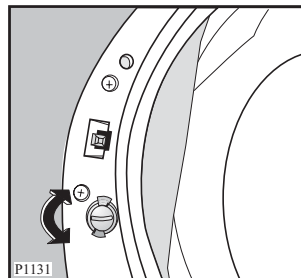

To disable this device and restore the possibility of closing the door, rotate the button anti-clockwise until the groove is vertical.

Product description

Your new appliance meets all modern requirements for effective treatment of laundry with low water, energy and detergent consumption.

The **Eco Valve** allows total use of detergent and reduces water consumption so saving energy.

- 1** Detergent dispenser drawer
- 2** Control panel
- 3** Door opening handle
- 4** Drain filter
- 5** Adjustable feet

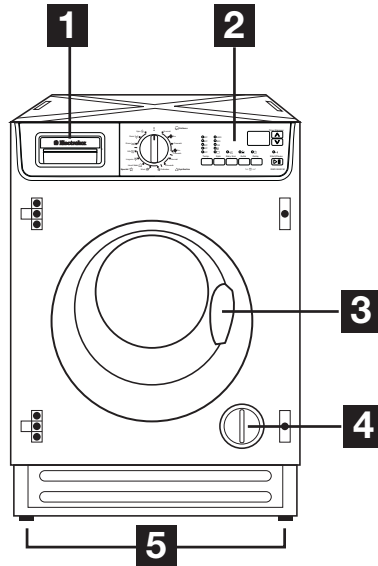

Detergent dispenser drawer

-  Prewash
-  Wash
-  Fabric Softener

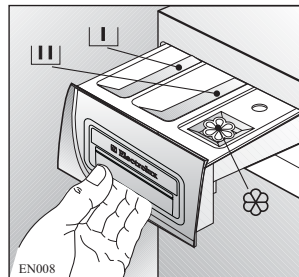

Control panel

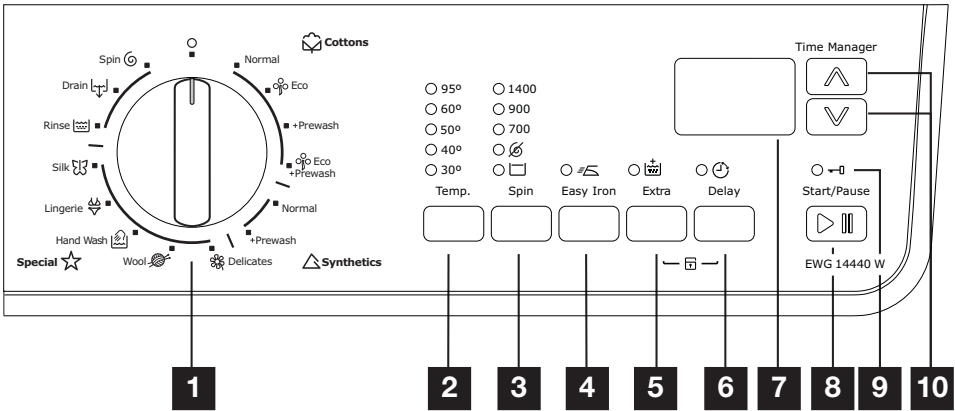

- 1** Programme selector dial
- 2** Temperature button
- 3** Spin reduction button
- 4** «Easy Iron» button
- 5** «Extra Rinse» button
- 6** «Delay» button
- 7** Display
- 8** Start/Pause button
- 9** «Door locked» light
- 10** Time manger buttons

Use

First Use



- Ensure that the electrical and water connections comply with the installation instructions.
- Remove the polystyrene block and any material from the drum.
- Pour 2 litres of water into the main wash compartment  of the detergent drawer in order to activate the ECO valve. Then run a cotton cycle at 95°C, without any laundry in the machine, to remove any manufacturing residue from the drum and tub. Pour 1/2 a measure of detergent into the dispenser drawer and start the machine.

Acoustic signals

The machine is provided of an acoustic device, which sounds in the following cases:

- at the end of the cycle
- in the event of operating problems

By pressing the «Extra Rinse» «Delay» and buttons simultaneously for about 6 seconds, the acoustic signal is deactivated (except for the events of operating problems).

By pressing these 2 buttons again, the the acoustic signal is reactivated.



Child safety lock

This device permits you to leave the appliance unsupervised without having the worry that children might be injured by or cause damage to the appliance.

This function remains able also when the washing machine is not working.

There are two different ways to set this option:

- before pressing the «Start/Pause»: it will be impossible to start the machine.
- after pressing the «Start/Pause» it will be impossible to change any other programme or option.

To enable (disable) this option press simultaneously for about 6 seconds «Extra»  and «Delay» buttons until the icon  appears (disappears) on (from) the display.

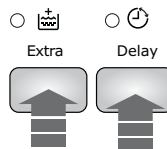
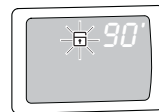



Daily Use

Load the laundry

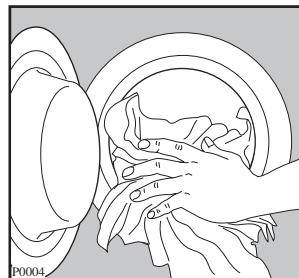
Open the door by carefully pulling the door handle outwards. Place the laundry in the drum, one item at a time, shaking them out as much as possible. Close the door.



Measure out the detergent and the fabric softener

Pull out the dispenser drawer until it stops. Measure out the amount of detergent required, pour it into the main wash compartment  and, if you wish to carry out a programme with the «**prewash**» phase, pour it into the compartment marked .

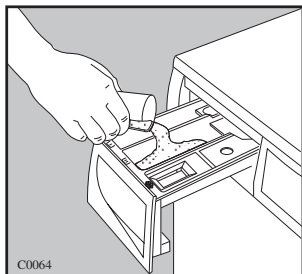

If required, pour fabric softener into the compartment marked  (the amount used must not exceed the "MAX" mark in the drawer). Close the drawer gently.

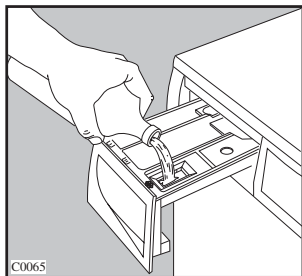









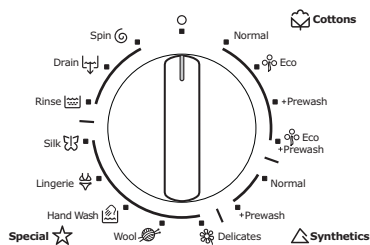





Select the required programme

Turn the programme selector dial to the required programme.

The Start/Pause light starts to flash and the Display shows the duration of the selected programme.

The selector dial is divided into following sections:



- Cottons : «Normal», « Eco», «+Prewash» and « Eco+Prewash»
- Synthetics : «Normal» and «+Prewash».
- Special : «Delicates », «Wool », «Handwash », «Lingerie  » and «Silk ».
- «Rinse », «Drain  » and «Spin  ».

The selector dial can be turned either clockwise or anticlockwise. Position «**O**» to Reset programme/ Switching OFF of the machine.

At the end of the programme the selector dial must be turned to position «O», to switch the machine off.



Attention!

If you turn the programme selector dial to another programme when the machine is working, the **red** «Start/Pause» pilot light will flash 3 times and the message **Err** will appear on the display to indicate a wrong selection. The machine will not perform the new selected programme.

Programme Option buttons

Depending on the programme, different functions can be combined. These must be selected after choosing the desired programme and before depressing the «Start/Pause» button.

In any case if you select an option not compatible with the selected programme or option, the message **Err** will be displayed on the display for a few seconds, and the integrated **red** «Start/Pause» light will start flashing.

Select the temperature

- 95°
- 60°
- 50°
- 40°
- 30°

Temp.



Press this button repeatedly to increase or decrease the temperature, if you want your laundry to be washed at a temperature different from the one proposed by the washing machine.

Maximum temperatures are 95°C for Cottons, 60°C for Synthetics, 40°C for Delicates, Wool, fabrics to be handwashed and Lingerie programmes, and 30°C for Silk.

Select the spin speed, No spin or Rinse Hold option

Press the Spin button repeatedly to change the spin speed, if you want your laundry to be spun at a speed different from the one proposed by the washing machine.

- 1400
 - 900
 - 700
 -
 -
- Spin



Maximum speeds are:

- for all Cottons: 1400 rpm;
- for Synthetics, Wool, Handwash and Lingerie: 900 rpm;
- for delicate fabrics and Silk: 700 rpm.

No spin option eliminates all the spin phases (in some programmes increases also the number of rinses).

Rinse Hold : by selecting this option the water of the last rinse is not emptied out to prevent the fabrics from creasing.

When the programme has finished the display shows a «0.00» flashing, the «Door locked» pilot light is still on, the «Start/Pause» light is off and the door is locked to indicate that the water must be emptied out.

To empty out the water:

- turn the programme selector dial to «0»
- select the Drain or Spin programme
- reduce the spin speed if needed, by means of the relevant button
- depress «Start/Pause» button
- at the end of the programme, the display shows a «0.00» flashing. The pilot light (Door locked) goes out and the door can be opened.

Select the Easy Iron option

Selecting this button the laundry is gently washed and spun to avoid any creasing. In this way ironing is easier.

Furthermore the machine will perform some additional rinses for cotton and synthetics.



Easy Iron



This function can be used for cotton and synthetic fabrics.

Select the Extra Rinse option



Extra



The machine performs some additional rinses.

This option is recommended for people who are allergic to detergents, and in areas where the water is very soft.

Select the Delay start

Before you start the programme, if you wish to delay the start, press the «Delay» button repeatedly, to select the desired delay.

The corresponding light will illuminate.

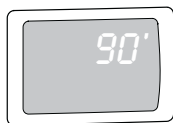

Delay



The selected delay time value (up to 20 hours) will appear on the display for about 3 seconds, then the duration of the programme will appear again.

You must select this option after you have set the programme and before you press the «Start/Pause» button.

If you wish to add laundry in the machine during the delay time you will press «Start/Pause» button to put the machine in pause. Add the laundry, close the door and press «Start/Pause» button again.

You can cancel the delay time at any moment, before you press the Start/Pause button.

The wash programme can be delayed from 30 min - 60 min - 90 min, 2 hours and then by 1 hour up to a maximum of 20 hours by means of this button.

Selecting the delayed start.

- Select the programme and the required options.
- Select the delay start.
- Depress «Start/Pause» button: the machine starts its hourly countdown.

The programme will start after the selected delay has expired.

Cancelling the delayed start

- Depress «Start/Pause» button.
- Depress «Delay» button, the symbol  is displayed.

- Depress «Start/Pause» button again to start immediately the programme.

The Delay **cannot** be selected with **Drain**  programme.

Display

The display shows the following information:

Duration of the selected programme

After selecting a programme, the duration is displayed in hours and minutes (for example **2.05**).

The duration is calculated automatically on the basis of the maximum recommended load for each type of fabric.



After the programme has started, the time remaining is updated every minute.

Washing programme phase icons

By selecting the wash programme, the washing programme phase icons corresponding to the various phases making up the programme are shown in the bottom of the display.

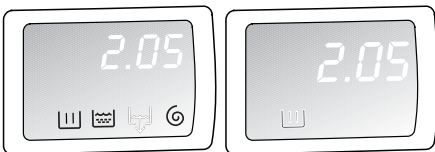

After you have pressed the «Start/Pause» button and the machine has started, the  (Door locked) pilot light is on and only the phase running icon stays on.

When the programme has finished, three flashing zero «**0.00**».

Delay

The selected delay (20 hours max) set by means of the relevant button appears on the display for about 3 seconds, then the duration of the previously selected programme is displayed.

The delay time value decreases by one unit every hour and then, when 1 hour remains, the time decreases every minute.

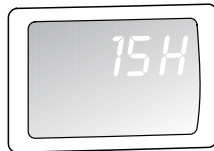

Incorrect option selection

If an option which is not compatible with the set wash programme is selected, the message **Err** is displayed for few seconds and the integrated **red** «Start/Pause» light start flashing.



Alarm codes

In the event of operating problems, some alarm codes can be displayed, for example **E20** (see paragraph «Something not working”).



End of programme

When the programme has finished three flashing zero is displayed, the  (Door locked) and the «Start/Pause» go out and the door can be opened.



Heating phase

During the washing cycle the display shows the temperature icon to indicate that the appliance has started the heating phase of the water in the tub.



Select the Start/Pause



To start the selected programme, press the «Start/Pause» button; the green pilot light stops flashing.

The «door locked»  pilot light illuminates to indicate that the appliance starts operating and the door is locked.

The “door”  pilot light indicates if the door can be opened:

- light on: the door cannot be opened. The appliance is running.
- light off: the door can be opened. The washing programme is finished.

To interrupt a programme which is running, depress the «Start/Pause» button: the green pilot light starts to flash.

To restart the programme from the point at which it was interrupted, **press** the «Start/Pause» button **again**.



If you have chosen a delayed start, the machine will begin the countdown.

If an incorrect option is selected, an integrated **red** pilot light of the «Start/Pause» button flashes 3 times the message **Err** is displayed for few seconds.

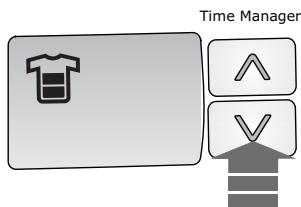



Select the “Time Manager” option



This function allows you to modify the washing time, automatically proposed by the washing machine.

By pressing the «**Time manager**» buttons  and  repeatedly, the duration of the washing cycle can be increased or decreased.

The soil level icon  visualized on the display will change to indicate which type of soil degree you have chosen.

Soil Level	Icon	Type of fabric
Intensive		For heavy soiled items
Normal		For normal soiled items
Daily		For daily soiled items
Light		For slightly soiled items
Quick		For very slightly soiled items
Super Quick (*)		For items used or worn for a short time

(*) Max. load for cotton: 2.5 kg.
Max. load for synthetic and delicate: 1.5 kg.









Note

Once the programme has started the **Time manager** option cannot be changed.



Attention!

The «Time Manager» option cannot be selected with the **Eco** programmes. The availability of these soil level icons change according to the type of fabric as shown in the following chart:

Fabric	Soil Level					
Cottons						
95°C	X	X	X	X	X	X
60°C	X	X	X	X	X	X
50°C	X	X	X	X	X	X
40°C	X	X	X	X	X	X
30°C	X	X	X	X	X	X
Synthetics						
60°C		X	X	X		X
50°C		X	X	X		X
40°C		X	X	X		X
30°C		X	X	X		X
Delicates						
40°C		X	X	X		X
30°C		X	X	X		X

Altering an option or a running programme

It is possible to change any option before the programme carries it out. Before you make any change, you must pause the washing machine by pressing the «Start/Pause» button. (Only the Time Manager option **cannot** be modified after the programme has started.)

Changing a running programme is possible **only by resetting it**. Turn the programme selector dial to «**O**» and then to the new programme position. Start the new programme by depressing the «Start/Pause» button again. The washing water in the tub will not emptied out.

Interrupting a programme

Depress the «Start/Pause» button to interrupt a programme which is running, the corresponding light starts to flash. Depress the button again to restart the programme.

Cancelling a programme

Turn the selector dial to «O» to cancel a programme which is running. Now you can select a new programme.

Opening the door after the programme has started

First set the machine to pause by pressing the «Start/Pause» button.

If the «Door locked»  light goes off, the door can be opened.

If the «Door locked»  light does not go off, this means that the machine is already heating, that the water level is above the bottom edge of the door or that the drum is turning. In this case the door can not be opened.



If you cannot open the door but you need to open it you have to switch the machine off by turning the selector dial to «O».

After few minutes the door can be opened **(pay attention to the water level and temperature!)**.

At the end of the programme

The machine stops automatically.

Three flashing “0.00” will appear on the display, the buzzer sounds for some minutes, the Start/Pause light and the «Door locked»  pilot light go off: the door can be opened.

If the **Rinse Hold**  option have been selected, the Start/Pause light goes off, a flashing “0.00” will appear on the display, «Door locked»  pilot light is still alight: the door remains locked to indicate that the water must be emptied out before opening the door.

To empty out the water please read the steps on the Rinse Hold option paragraph.

At the end of the cycle, turn the programme selector dial to «O» to switch the machine off.

Remove the laundry from the drum and carefully check that the drum is empty. If you do not intend to carry out another wash, close the water tap.

Leave the door open to prevent the formation of mildew and unpleasant smells.

Washing hints



Sorting the laundry

Follow the wash code symbols on each garment label and the manufacturer's washing instructions. Sort the laundry as follows: whites, coloureds, synthetics, delicates, woollens.

Temperatures

95°/90°	for normally soiled white cottons and linen (e.g. tea cloths, tablecloths, sheets...)
50°/60°	for normally soiled, colour fast garments (e.g. shirts, night dresses, pyjamas....) in linen, cotton or synthetic fibres and for lightly soiled white cotton (e.g. underwear).
30°-40°	for delicate items (e.g. net curtains), mixed laundry including synthetic fibres and woollens bearing the label «pure new wool, machine washable, non-shrink».

Before loading the laundry

Never wash whites and coloureds together. Whites may lose their "whiteness" in the wash.

New coloured items may run in the first wash; they should therefore be washed separately the first time.

Make sure that no metal objects are left in the laundry (e.g. hair clips, safety pins, pins).

Button up pillowcases, close zip fasteners, hooks and poppers. Tie any belts or long tapes.

Remove persistent stains before washing.

Rub particularly soiled areas with a special detergent or detergent paste.

Treat curtains with special care.

Remove hooks or tie them up in a bag or net.

Maximum loads

Recommended loads are indicated in the programme charts.

General rules:

Cotton, linen: drum full but not too tightly packed;

Synthetics: drum no more than half full;

Delicate fabrics and woollens: drum no more than one third full.

Washing a maximum load makes the most efficient use of water and energy.

For heavily soiled laundry, reduce the load size.

Laundry weights

The following weights are indicative:

bathrobe	1200 g
napkin	100 g
quilt cover	700 g
sheet	500 g
pillow case	200 g
tablecloth	250 g
towelling towel	200 g
tea cloth	100 g
night dress	200 g
ladies' briefs	100 g
man's work shirt	600 g
man's shirt	200 g
man's pyjamas	500 g
blouse	100 g
men's underpants	100 g

Removing stains

Stubborn stains may not be removed by just water and detergent. It is therefore advisable to treat them prior to washing.

Blood: treat fresh stains with cold water. For dried stains, soak overnight in water with a special detergent then rub in the soap and water.

Oil based paint: moisten with benzine stain remover, lay the garment on a soft cloth and dab the stain; treat several times.

Dried grease stains: moisten with turpentine, lay the garment on a soft surface and dab the stain with the fingertips and a cotton cloth.

Rust: oxalic acid dissolved in hot water or a rust removing product used cold. Be careful with rust stains which are not recent since the cellulose structure will already have been damaged and the fabric tends to hole.

Mould stains: treat with bleach, rinse well (whites and fast coloureds only).

Grass: soap lightly and treat with bleach (whites and fast coloureds only).

Ball point pen and glue: moisten with acetone (*), lay the garment on a soft cloth and dab the stain.

Lipstick: moisten with acetone as above, then treat stains with methylated spirits. Remove any residual marks from white fabrics with bleach.

Red wine: soak in water and detergent, rinse and treat with acetic or citric acid, then rinse. Treat any residual marks with bleach.

Ink: depending on the type of ink, moisten the fabric first with acetone (*), then with acetic acid; treat any residual marks on white fabrics with bleach and then rinse thoroughly.

Tar stains: first treat with stain remover, methylated spirits or benzine, then rub with detergent paste.

(*) do not use acetone on artificial silk.

Detergents and additives

Good washing results also depend on the choice of detergent and use of the correct quantities to avoid waste and protect the environment. Although biodegradable, detergents contain substances which, in large quantities, can upset the delicate balance of nature.

The choice of detergent will depend on the type of fabric (delicates, woollens, cottons, etc.), the colour, washing temperature and degree of soiling.

All commonly available washing machine detergents may be used in this appliance:

- powder detergents for all types of fabric,
- powder detergents for delicate fabrics (60°C max) and woollens,
- liquid detergents, preferably for low temperature wash programmes (60°C max) for all types of fabric, or special for woollens only.

The detergent and any additives must be placed in the appropriate compartments of the dispenser drawer before starting the wash programme.

If using concentrated powder or liquid detergents, a programme **without** prewash must be selected.

The washing machine incorporates a recirculation system which allows an optimal use of the concentrated detergent.

Pour liquid detergent into the dispenser drawer compartment marked  **just before** starting the programme.

Any fabric softener or starching additives must be poured into the compartment marked  before starting the wash programme.

Follow the product manufacturer's recommendations on quantities to use and **do not exceed the «MAX» mark in the detergent dispenser drawer.**

Quantity of detergent to be used

The type and quantity of detergent will depend on the type of fabric, load size, degree of soiling and hardness of the water used.

Water hardness is classified in so-called "degrees" of hardness.

Information on hardness of the water in your area can be obtained from the relevant water supply company, or from your local authority.

Follow the product manufacturers' instructions on quantities to use.













Use less detergent if:



- you are washing a small load,
- the laundry is lightly soiled,
- large amounts of foam form during washing.





Degrees of water hardness			
Level	Characteristic	Degrees	
		German °dH	French °T.H.
1	soft	0-7	0-15
2	medium	8-14	16-25
3	hard	15-21	26-37
4	very hard	> 21	> 37





i International wash code symbols







These symbols appear on fabric labels, in order to help you choose the best way to treat your laundry.

<p>Energetic wash</p>   <p>Delicate wash</p>	 <p>Max. wash temperature 95°C</p>	 <p>Max. wash temperature 60°C</p> 	 <p>Max. wash temperature 40°C</p>  	 <p>Max. wash temperature 30°C</p> 	 <p>Hand wash</p>	 <p>Do not wash at all</p>
---	---	---	---	---	--	--



 <p>Bleaching</p>	 <p>Bleach in cold water</p>	 <p>Do not bleach</p>
---	---	--

 <p>Ironing</p>	 <p>Hot iron max 200°C</p>	 <p>Warm iron max 150°C</p>	 <p>Lukewarm iron max 110°C</p>	 <p>Do not iron</p>
---	---	--	--	--







 <p>Dry cleaning</p>	 <p>Dry cleaning in all solvents</p>	 <p>Dry cleaning in perchlorethylene, petrol, pure alcohol, R 111 & R 113</p>	 <p>Dry cleaning in petrol, pure alcohol and R 113</p>	 <p>Do not dry clean</p>
--	---	--	---	---

 <p>Drying</p>	 <p>Flat</p>	 <p>On the line</p>	 <p>On clothes hanger</p>	 <p>high temperature</p>  <p>low temperature</p> <p>Tumble dry</p>	 <p>Do not tumble dry</p>
--	---	--	--	--	---

Washing programmes

Programme/ Temperature	Type of laundry	Options	Description of programme
 Cottons Normal 90° - 30°	White and coloured cotton normally soiled	Spin Red./No Spin/ Rinse Hold Easy Iron, Extra Rinse, Time Manager	Main wash from 90°C to 30°C 3 rinses Long spin at the max spin
 Cottons  Eco 90° - 40°	White and fast coloured cotton economy, lightly - normally soiled items	Spin Red./No Spin/ Rinse Hold, Easy Iron, Extra Rinse	Main wash from 90°C to 40°C 3 rinses Long spin at the max spin
 Cottons + Prewash 90° - 30°	White and coloured cotton heavily soiled	Spin Red./No Spin/ Rinse Hold Easy Iron, Extra Rinse, Time Manager	Prewash at 30°C Main wash from 90°C to 30° 3 rinses Long spin (max spin)
 Cottons  Eco+ Prewash 90° - 40°	White and fast coloured cotton economy, normally soiled	Spin Red./No Spin/ Rinse Hold, Easy Iron, Extra Rinse	Prewash at 30°C Main wash from 90°C to 40°C 3 rinses Long spin (max spin)
 Synthetics Normal 60° - 30°	Synthetic or mixed fabrics normally soiled	Spin Red./No Spin/ Rinse Hold Easy Iron, Extra Rinse, Time Manager	Main wash from 60°C to 30° 3 rinses Short spin at 900 rpm
 Synthetics + Prewash 60° - 30°	Synthetic or mixed fabrics heavily soiled	Spin Red./No Spin/ Night Cycle/ Rinse Hold Easy Iron, Extra Rinse, Time Manager	Prewash at 30°C Main wash from 60°C to 30° 3 rinses Short spin at 900 rpm
 Delicates 40° - 30°	Delicate fabrics, for example curtains.	No Spin/ Rinse Hold Extra Rinse, Time Manager	Main wash from 40° to 30° 3 rinses Short spin at 700 rpm
O	For cancelling the wash programme which is running and for switching the machine off.		

Washing programmes

Programme/ Temperature	Type of laundry	Options	Description of programme
 Wool 40° - 30°	Specially programme for wool garments bearing the "Pure new wool, non-shrink, machine washable" label.	Spin Red./ No Spin/Rinse Hold	Main wash from 40° to 30° 3 rinses Short spin at 900 rpm
 Handwash 40° - 30°	Special programme for hand washing fabrics.	Spin Red./ No Spin/ Rinse Hold	Main wash from 40° to 30° 3 rinses Short spin at 900 rpm
 Lingerie 40°	Extremely delicate items	Spin Red./No Spin/ Rinse Hold	Main wash at 40°C 3 rinses Short spin at max 900 rpm
 Silk 30°	Silk items to be gentle washed and spun.	No Spin/Rinse Hold	Main wash at 30°C 2 rinses Short spin at 700 rpm
 Rinse	Separate rinse cycle for cotton hand washed items.	Spin Red./No Spin/ Rinse Hold, Easy Iron, Extra Rinse	3 rinses Long spin at the max spin
 Drain	For emptying out the last rinse water in programmes with the Rinse Hold ption.		Draining of water
 Spin	Separate spin for cottons.	Spin Reduction	Drain and long spin



Cottons.....5 kg
Synthetics.....2.5 kg

Delicates2.5 kg
Wool/Handwash1 kg
Silk/Lingerie1 kg

Programme information



Economy programmes

This programme can be selected for slightly or normally soiled cotton and synthetic items. The temperature will decrease and the washing time will be extended. This allows to obtain a good washing efficiency by saving energy.



Wool and



Handwash

Washing programme for machine washable wool as well as for hand washable woollens and delicate fabrics with the “hand washing” care symbol .



Silk

Delicate washing programme suitable for silk and mixed synthetics items. Washing temperature is 30°C. The maximum spin speed is automatically reduced to 700 rpm.





Rinses

With this programme it is possible to rinse and spin cotton garments which have been washed by hand. The machine performs 3 rinses, followed by a final spin at maximum speed. The spin speed can be reduced by depressing the corresponding button.



Drain

For emptying out the water of the last rinse in programmes with the Rinse Hold  option. Turn first the programme selector dial to «**O**», then select programme  Drain and depress the «Start/Pause» button.



Spin

Separate spin for hand washed garments and after programmes with Rinse Hold  option. Before selecting this programme the selector dial must be turned to «**O**». You can choose the speed by means of the relevant button to adapt it to the fabrics to be spun.

O = Cancelling/OFF

To reset a programme and to switch off the machine turn the selector dial to «**O**». Now can a new programme be selected.

Care and cleaning



You must **DISCONNECT** the appliance from the electricity supply, before you can carry out any cleaning or maintenance work.

Descaling

The water we use normally contains lime. It is a good idea to periodically use a water softening powder in the machine. Do this separately from any laundry washing, and according to the softening powder manufacturer's instructions. This will help to prevent the formation of lime deposits.

After each wash

Leave the door open for a while. This helps to prevent mould and stagnant smells forming inside the appliance. Keeping the door open after a wash will also help to preserve the door seal.

Maintenance Wash

With the use of low temperature washes it is possible to get a build up of residues inside the drum.

We recommend that a maintenance wash be performed on a regular basis.

To run a maintenance wash:

- The drum should be empty of laundry.
- Select the hottest cotton wash programme.
- Use a normal measure of detergent, must be a powder with biological properties.

External cleaning

Clean the exterior cabinet of the appliance with soap and water only, and then dry thoroughly.

Cleaning the dispenser drawer

The washing powder and additive dispenser drawer should be cleaned regularly.

Remove the drawer by pressing the catch downwards and by pulling it out. Flush it out under a tap, to remove any traces of accumulated powder.

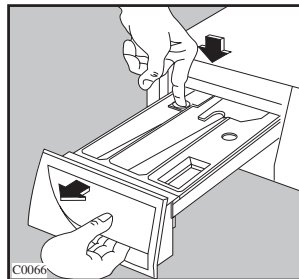

To aid cleaning, the top part of the additive compartment should be removed.

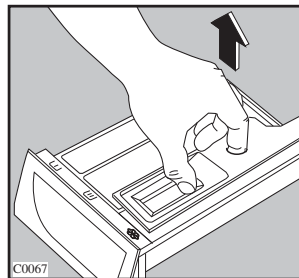

Cleaning the drawer recess

Having removed the drawer, use a small brush to clean the recess, ensuring that all washing powder residue is removed from the upper and lower part of the recess.

Replace the drawer and run the rinse programme without any clothes in the drum.

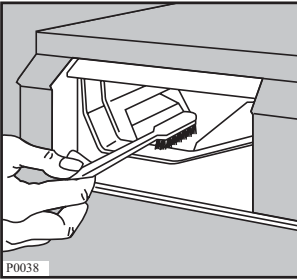

Cleaning the water drain filter

A clean filter is important for the correct operating of the machine, and should therefore be cleaned after every washing programme.

Place a container underneath to catch any spillage. If the filter is blocked and the machine is unable to drain you will need to drain the water manually from the machine at this stage.

To do this, unhook the drain hose from the standpipe or sink and hold the end of the hose over a bowl on the floor. The water should drain by gravity into the bowl.

When the bowl is full, hook the hose back up and empty the bowl. Repeat the procedure until water stops flowing out.

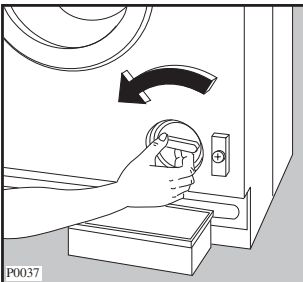

Unscrew and remove the filter.

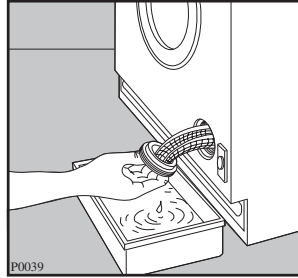

Clean carefully under a fast running tap.

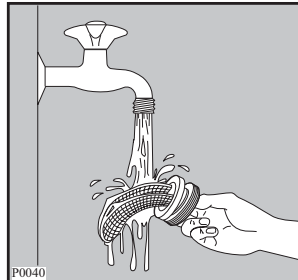

Warning!

When the appliance is in use and depending on the programme selected there can be hot water in the filter. Never remove the filter during a wash cycle, always wait until the appliance has finished the cycle, and is empty. When replacing the filter, ensure it is securely retightened so as to stop leaks and young children being able to remove it.

Cleaning the water inlet filter

If your water is very hard or contains traces of lime deposit, the water inlet filter may become clogged.

It is therefore a good idea to clean it from time to time.

Turn off the water tap. Unscrew the water inlet hose. Clean the filter using a hard bristle brush. Tighten up the inlet hose.

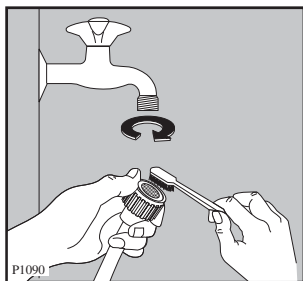

The dangers of freezing

If the machine is exposed to temperatures below 0°C, certain precautions should be taken.

- Turn off the water tap.
- Unscrew the inlet hose.
- Unhook the drain hose from the rear support and position the end of this hose and that of the inlet hose in a bowl. Run the draining programme  «Drain».
- Disconnect the appliance.
- Screw the inlet hose and reposition the drain hose.
- When you intend to start the machine up again, make sure that the room temperature is above 0°C.

Important!

Every time you drain the water through the emergency emptying hose you must pour 2 litres of water into the main wash compartment of the detergent drawer and then run the drain programme. This will activate the ECO VALVE device avoiding that part of the detergent remains unused at next washing.

Emergency emptying out

If the water is not discharged, proceed as follows to empty out the machine:

- pull out the plug from the power socket;
- close the water tap;
- if necessary, wait until the water has cooled down;
- Unscrew and remove the filter;
- place a bowl on the floor. The water should drain by gravity into the bowl. When the bowl is full, empty the bowl. Repeat the procedure until water stops flowing out;
- clean the filter if necessary as previously described;
- screw the filter again.

Something not working







Certain problems are due to lack of simple maintenance or oversights, which can be solved easily without calling out an engineer. Before contacting your local Service Centre, please carry out the checks listed below.

During machine operation it is possible that the **red** «Start/Pause» pilot light flashes, the buzzer sounds and one of the following alarm codes appears on the display to indicate that the machine is not working:

- **E10**: problem with the water supply
- **E20**: problem with water draining
- **E40**: door open.

Once the problem has been eliminated, press the «Start/Pause» button to restart the programme. If after all checks, the problem persists, contact your local Service Centre.

Malfunction	Possible cause	Solution
The washing machine does not start:	<ul style="list-style-type: none"> ● The door has not been closed. E40 ● The plug is not properly inserted in the power socket. ● There is no power at the socket. ● The main fuse or the fuse in the plug has blown. ● The selector dial is not correctly positioned and the «Start/Pause» button has not been depressed. ● The «Delay» has been selected. 	<ul style="list-style-type: none"> ● Close firmly the door. ● Insert the plug into the power socket. ● Please check your domestic electrical installation. ● Replace the fuse. ● Please turn the selector dial and press the «Start/Pause» button again. ● If the laundry are to be washed immediately, cancel the delay start.
The machine fills then empties immediately:	<ul style="list-style-type: none"> ● The end of the drain hose is too low. 	<ul style="list-style-type: none"> ● Refer to relevant paragraph in “water drainage” section.
The machine does not fill:	<ul style="list-style-type: none"> ● The water tap is closed. E10 ● The inlet hose is squashed or kinked. E10 ● The filter in the inlet hose is blocked. E10 ● The door is not properly closed. E40 	<ul style="list-style-type: none"> ● Open the water tap. ● Check the inlet hose connection. ● Clean the water inlet hose filter. ● Close firmly the door.

Malfunction	Possible cause	Solution
The machine does not empty and/or does not spin:	<ul style="list-style-type: none"> ● The drain hose is squashed or kinked. <i>E20</i> ● The drain pump is clogged. <i>E20</i> ● The option  has been selected. ● The option  has been selected. ● The laundry is not evenly distributed in the drum. 	<ul style="list-style-type: none"> ● Check the drain hose connection. ● Clean the drain pump. ● Select the programme  or . ● Select the programme . ● Redistribute the laundry.
The door will not open:	<ul style="list-style-type: none"> ● The programme is still running. ● The door lock has not been released. ● There is water in the drum. 	<ul style="list-style-type: none"> ● Wait the end of washing cycle. ● Wait for the «Door locked» pilot light  going out. ● Select drain or spin programme to empty out the water.
No water is visible in the drum	<ul style="list-style-type: none"> ● Machines based on modern technology operate very economically using very little water without affecting performance. 	
There is water on the floor:	<ul style="list-style-type: none"> ● Too much detergent or unsuitable detergent (creates too much foam) has been used. ● Check whether there are any leaks from one of the inlet hose fittings. It is not always easy to see this as the water runs down the hose; check to see if it is damp. ● The drain hose is damaged. ● The cap on the emergency emptying hose has not been replaced after cleaning the pump. 	<ul style="list-style-type: none"> ● Reduce the detergent quantity or use another one. ● Check the water inlet hose connection. ● Change it with a new one. ● Put the cap back on the emergency emptying and place the latter back in its seat.

Malfunction	Possible cause	Solution
Unsatisfactory washing results:	<ul style="list-style-type: none"> ● Too little detergent or unsuitable detergent has been used. ● Stubborn stains have not been treated prior to washing. ● The correct temperature was not selected. ● Excessive laundry load. 	<ul style="list-style-type: none"> ● Increase the detergent quantity or use another one. ● Use commercial products to treat the stubborn stains. ● Check if you have selected the correct temperature. ● Introduce into the drum less laundry.
The machine vibrates or is noisy:	<ul style="list-style-type: none"> ● The transit bolts and packing have not been removed. ● The support feet have not been adjusted. ● The laundry is not evenly distributed in the drum. ● Maybe there is very little laundry in the drum. 	<ul style="list-style-type: none"> ● Check the correct installation of the appliance. ● Check the correct levelling of the appliance. ● Redistribute the laundry. ● Load more laundry.
The machine makes an unusual noise	<ul style="list-style-type: none"> ● The machine is fitted with a type of motor which makes an unusual noise compared with other traditional motors. This new motor ensures a softer start and more even distribution of the laundry in the drum when spinning, as well as increased stability of the machine. 	

Malfunction	Possible cause	Solution
<p>Spinning starts late or the machine does not spin:</p>	<ul style="list-style-type: none"> • The electronic unbalance detection device has cut in because the laundry is not evenly distributed in the drum. The laundry is redistributed by reverse rotation of the drum. This may happen several times before the unbalance disappears and normal spinning can resume. If, after 10 minutes, the laundry is still not evenly distributed in the drum, the machine will not spin. In this case, redistribute the load manually and select the spin programme. 	<ul style="list-style-type: none"> • Redistribute the laundry.



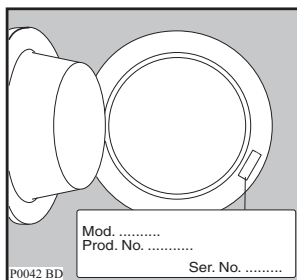









If you are unable to identify or solve the problem, contact our service centre. Before telephoning, make a note of the model, serial number and purchase date of your machine: the Service Centre will require this information.



Technical data



Dimensions	Width	60 cm
	Height	82 cm
	Depth	54 cm
Electrical connection Voltage - Overall power - Fuse	Information on the electrical connection is given on the rating plate on the inner edge of the appliance door	
Water supply pressure	Minimum	0,05 MPa
	Maximum	0,8 MPa
Maximum Load	Cotton	5 kg
	Synthetics	2.5 kg
	Delicates	2.5 kg
	Wool/Handwash	1 kg
	Silk/Lingerie	1 kg
Spin Speed	Maximum	1400 rpm



Consumption values			
Programme	Water consumption (in litres)	Energy consumption (in kWh)	Programme duration (in minutes)
Cottons  Normal 90°	58	1.9	For the duration of the programmes, please refer to the display on the control panel.
Cottons  Eco  60° (*)	49	0.85	
Cottons  + Prewash 90°	68	2.05	
Cottons  Eco  + Prewash 60°	59	1.05	
Synthetics  Normal 60°	45	0.75	
Synthetics  + Prewash 60°	60	0.95	
Delicates  40°	57	0.5	
Wool  40°	53	0.4	
Handwash  40°	53	0.4	
Silk  30°	50	0.2	
Lingerie  40°	53	0.40	
Spin	-	-	
Drain	-	-	
Rinses	42	0.07	



The consumption data shown on this chart is to be considered purely indicative, as it may vary depending on the quantity and type of laundry, on the inlet water temperature and on the ambient temperature. It refers to the highest temperature for each wash programme.

(*) The programme «**Cottons  Eco **» at 60°C with a max load of 5 kg is the reference programme for the data entered in the energy label, in compliance with EEC 92/75 standards.

Installation



Unpacking

All transit bolts and packing must be removed before using the appliance. You are advised to keep all transit devices so that they can be refitted if the machine ever has to be transported again.

1. Using a spanner unscrew and remove the rear right bolt. Lay the machine gently on its back, making sure that the hoses are not squashed.

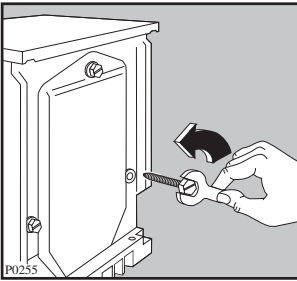

2. Remove the polystyrene base and take off the bottom panel by unscrewing the central screw..

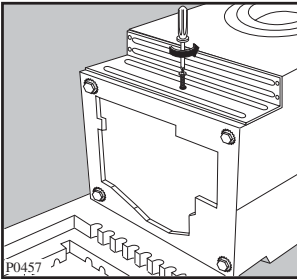

3. Carefully slide out the right polythene bag.

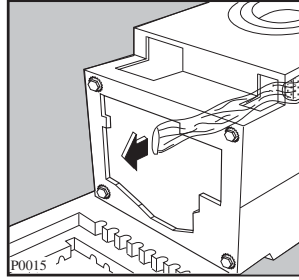

4. Repeat the operation for the left and central polythene bags.

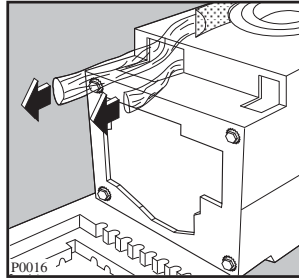

5. Re-fit the bottom panel using the 4 screws supplied with the door hinges (in the plastic bag) and the previously removed screw.

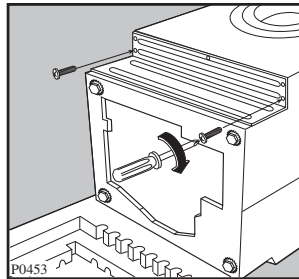

6. Set the machine upright and remove the two remaining bolts from the back.

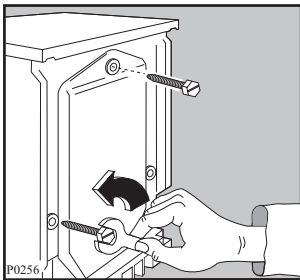

7. Plug the open holes with the plugs supplied with the instruction booklet.

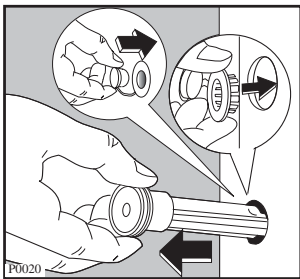

Positioning

Install the machine on a flat hard floor. Make sure that air circulation around the machine is not impeded by carpets, rugs etc.

Check that the machine does not touch the wall or other kitchen units. Level the washing machine by raising or lowering the feet. The feet may be tight to adjust as they incorporate a self locking nut, but the machine **MUST** be level and stable.

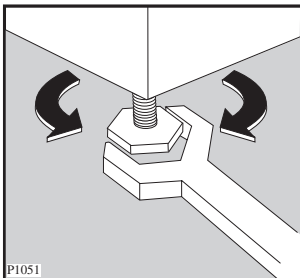

Any necessary adjustment can be made with a spanner. Accurate levelling prevents vibration, noise and displacement of the machine during operation. Never place cardboard, wood or similar materials under the machine to compensate for any unevenness in the floor.

Water inlet

Do not use the hose from your previous machine to connect to the water supply!

1. Connect the hose to a tap with a 3/4" thread.

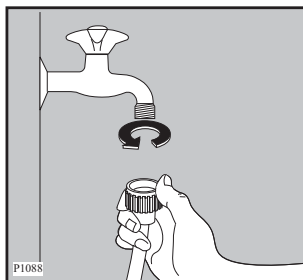

2. Set the hose correctly by loosening the ring nut. After positioning the inlet hose, be sure to tighten the ring nut again to prevent leaks.

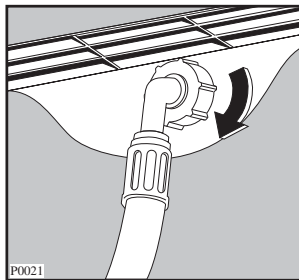

Always use the hose supplied with the appliance. The inlet hose must not be lengthened.

If it is too short and you do not wish to move the tap, you will have to purchase a new, longer hose specially designed for this type of use.

Note !



Installation should comply with local water authority and building regulations' requirements.

The appliance must be connected to a cold water supply.

A minimum water pressure of 0.05 MPa (0.5 bar) is required for safe operation of the appliance. If you cannot make the cold water connection direct from the rising mains, you may be able to operate the appliance from your cold water storage system.

There should be a minimum distance of 5.02m (16.5 ft) between the appliance's inlet and the bottom of the water storage tank.

Water drainage

This appliance is designed to be permanently plumbed into your home's drainage system using one of the following methods.

1. Into a drainage standpipe.

Firstly form a hook in the end of the drain hose using the «U» piece supplied.



Place the drain hose into your standpipe, which should have an internal diameter of approximately 38mm thus ensuring there is an air break between the drain hose and standpipe.

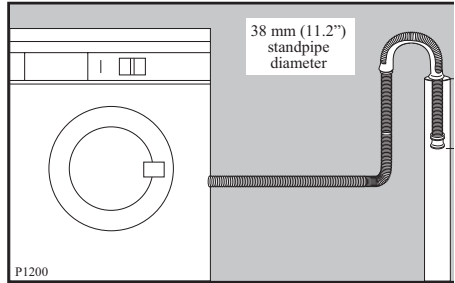

When discharging into a standpipe ensure that the top of the standpipe is no more than 90 cm (35.4") and no less than 60 cm (23.6") above floor level.

The drain hose may be extended to a maximum of 4 metres.

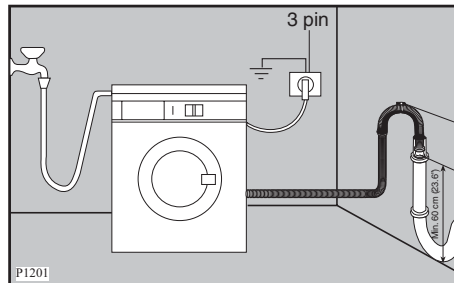

An additional drain hose and joining piece is available from your local Service Force Centre. The joining piece must have an internal diameter of 18 mm.

If your drain hose looks like this (see below) you do not require the «U» piece. Just push the hose firmly into the standpipe.

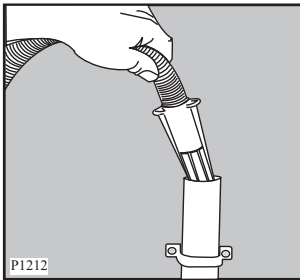

2. Onto a sink outlet spigot.

If the outlet spigot has not been used before, remove any blanking plug that may be in place.

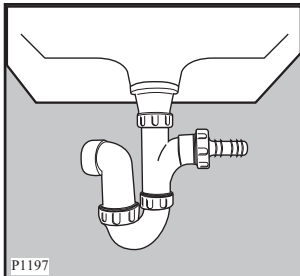

Push the drain hose onto the spigot and secure with a clip if required, ensure a loop is formed in the drain hose (see diagram) to prevent waste from the sink entering the washing machine.

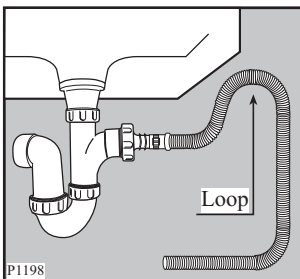

Important!

Before connecting the machine to new pipework or to pipework that has not been used for some time, run off a reasonable amount of water to flush out any debris that may have collected in the pipes.

Special conditions

If the floor is carpeted or covered with crumbly or soft material, insert a rigid support base under the feet to prevent noise, vibration or displacement. The base should protrude a few centimetres beyond the edges of the machine.



Warning !

The machine should NOT be placed on deep pile carpeting.

Note

Please ensure that when the appliance is installed it is easily accessible for the engineer in the event of a breakdown.

In the interest of the environment

Washing machines and dishwashers should be connected to the FOUL drainage system, the water will then be taken to a sewage works for treatment before being discharged safely into a river.

It is essential that these appliances are not connected to the surface water drainage system as this water is discharged directly into a river or stream and may cause pollution.

If you require any further advice please contact your local water authority.

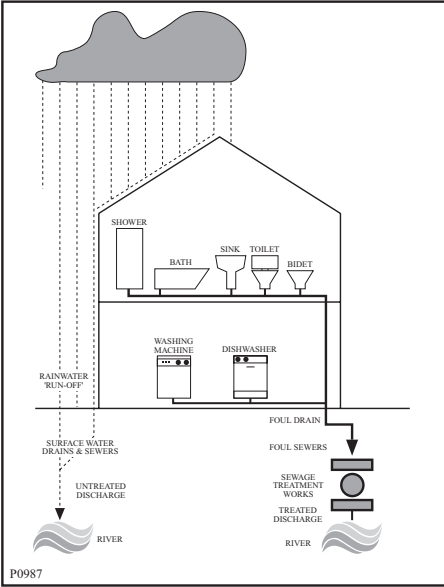

Electrical connection

Any electrical work required to install this appliance should be carried out by a qualified electrician or competent person.

Important!



This appliance must be earthed. The manufacturer declines any liability should this safety measure not be observed.

Before switching on, make sure the electricity supply voltage is the same as that indicated on the appliance's rating plate.

Important!



Information on the electrical connection is given on the rating plate on the inner edge of the appliance door.

The appliance is supplied with a 13amp plug fitted. In the event of having to change the fuse in the plug supplied, a 13amp ASTA approved (BS1363/A) fuse must be used.

Should the plug need to be replaced for any reason, proceed as described below.

The wires in the mains lead are coloured in accordance with the following code:

- Green and Yellow - Earth
- Blue - Neutral
- Brown - Live

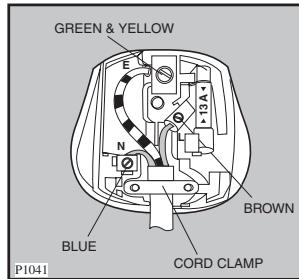

The wire coloured green and yellow must be connected to the terminal marked with the letter «E» or by the earth symbol \perp or coloured green and yellow.

The wire coloured blue must be connected to the terminal marked «N» or coloured black.

The wire coloured brown must be connected to the terminal marked «L» or coloured red.

Upon completion there must be no cut, or stray strands of wire present and the cord clamp must be secure over the outer sheath.

Warning!



A cut off plug inserted into a 13 amp socket is a serious safety (shock) hazard.

Ensure that the cut off plug is disposed of safely. Should the appliance power supply cable need to be replaced, this MUST be carried out by our Service Force Centre.



The power supply cable must be easily accessible after installing the appliance.

Permanent connection

In the case of permanent connection it is necessary that you install a double pole switch between the appliance and the electricity supply (mains), with a minimum gap of 3mm between the switch contacts and of a type suitable for the required load in compliance with the current electrical regulations. The switch must not break the yellow and green earth cable at any point.

Building-in

This appliance has been designed to be built into the kitchen furniture. The recess should have the dimensions shown in picture A.

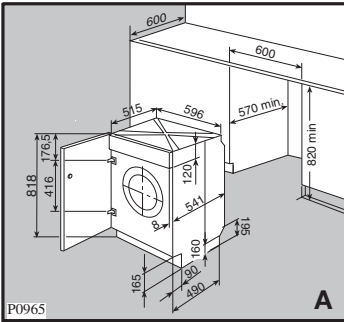

In this case it is sufficient to screw in the hinges (1) and the counter-magnet (6) provided with the appliance, at the right level (Fig. B).

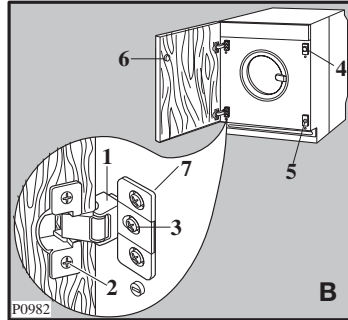

When installing the appliance into the kitchen furniture ensure, if possible, the hoses are placed in either of the two recesses on the back of the appliance. This will help to prevent the hoses from becoming kinked or trapped. Picture AB.

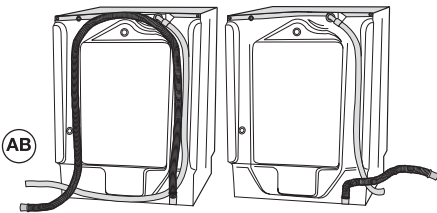

a) Door

The dimensions of the door should be:

- width 595-598 mm
- thickness 16-22 mm

The height (C-Fig. C) depends on the height of the adjacent furniture's base.

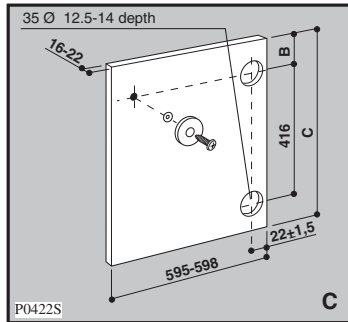

Preparation and assembly of the door

The machine is originally pre-arranged for the assembly of a door opening from right to left.

b) Hinges

To mount the hinges it is necessary to drill two holes (dia. 35 mm, depth 12.5-14 mm depending on the depth of door furniture) on the inner side of the door. The distance between the holes hobs fixing centres must be 416 mm.

The distance (B) from upper edge of the door to the centre of the hole depends on the adjacent furniture's dimensions. The required dimensions are given in the picture C.

The hinges will be fixed to the door by means of screws for wood (2-Fig. B) supplied with the appliance.

c) Mounting the door

Fix the hinges (1) to the machine by means of the M5x15 screws (3-Fig. B). The hinges can be adjusted to compensate for possible uneven thickness of the door.

To align the door perfectly it is necessary to loosen the screw (3-Fig. B), adjust the door and tighten the screw again.

d) Counter-magnet (6)

The appliance is pre-arranged for a magnetic closure of the door. To enable a correct operation of this device, it is necessary to screw the counter-magnet (6) (steel disk + rubber ring) into the inner side of the door.

Its position must correspond to the magnet (4) on the appliance (see picture D).

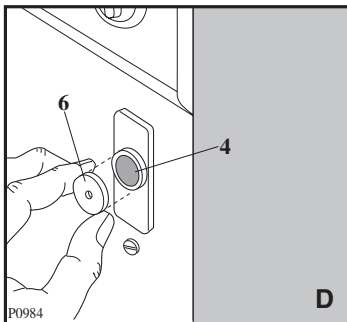

If the door has to be opened from left to right, invert the position of the plates (7), the magnet (4) and the plate (5) (Fig. B and E). Mount the countermagnet (6) and the hinges (1) as previously described.

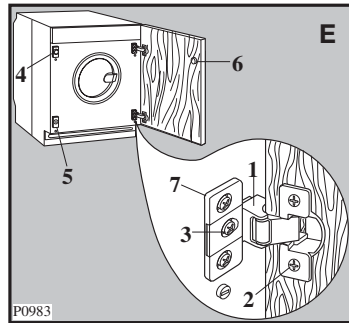

Recommendations regarding the construction and fitting of a base when the installation requires an integrated appliance to be raised.

Where the appliance has been raised by mounting onto a wooden base provided by the installer. The material used to construct the base should have a non slip surface, be water repellent and if possible be one solid piece.

If it is not possible to use one solid piece, due to the additional height required, ensure that any additional strips of timber are glued and screwed to the underside of the base (see Fig. F).

Drill four fixing holes see Fig. G

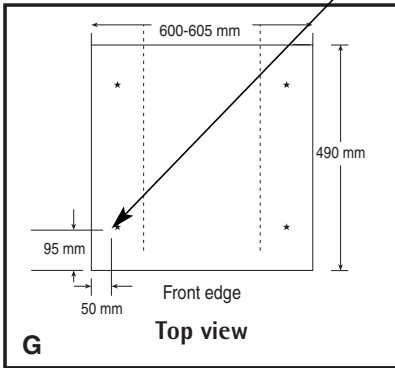

Position the base into the recess with its front edge as far forward as the adjoining plinth line will allow.

The reason for placing the base in this position is to allow a small strip of beading to be fitted in front of the appliance feet.

Fix the base firmly to the floor using four appropriate countersunk screws (see Fig. H).

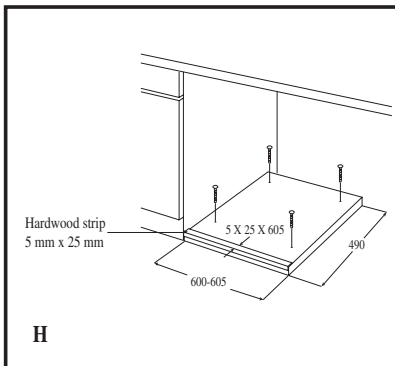

With the appliance installed adjust all four feet ensuring the machine is stable, and a clearance of approximately 5 mm is left between the top of the machine and the underside of the worktop.

A final check for stability should be carried out with the machine on spin with a load, this will identify the need for any further fine adjustment to the feet.

A strip of beading approximately 605 mm W, x 5 mm H, x 25 mm D must be screwed down into the base directly in front of the machine's feet, this will provide additional security.

If required an additional door magnet, part number 1242394-00/3 and disc, part number 1242393-00/5 are available from spare parts.

Environment concerns



Packaging materials

The materials marked with the symbol  are recyclable.

>PE<=polyethylene

>PS<=polystyrene

>PP<=polypropylene

This means that they can be recycled by disposing of them properly in appropriate collection containers.

Old machine

Use authorised disposal sites for your old appliance. Help to keep your country tidy!



The symbol  on the product or on its packaging indicates that this product may not be treated as household waste. Instead it shall be handed over to the applicable collection point for the recycling of electrical and electronic equipment. By ensuring this product is disposed of correctly, you will help prevent potential negative consequences for the environment and human health, which could otherwise be caused by inappropriate waste handling of this product. For more detailed information about recycling of this product, please contact your local city office, your household waste disposal service or the shop where you purchased the product.

Ecological hints



To save water, energy and to help protect the environment, we recommend that you follow these tips:

- Normally soiled laundry may be washed without prewashing in order to save detergent, water and time (the environment is protected too!).
- The machine works more economically if it is fully loaded.
- With adequate pre-treatment, stains and limited soiling can be removed; the laundry can then be washed at a lower temperature.
- Measure out detergent according to the water hardness, the degree of soiling and the quantity of laundry being washed.

Standard guarantee conditions

We, Electrolux, undertake that if within 12 months of the date of the purchase this Electrolux appliance or any part thereof is proved to be defective by reason only of faulty workmanship or materials, we will, at our option repair or replace the same FREE OF CHARGE for labour, materials or carriage on condition that:

- The appliance has been correctly installed and used only on the electricity supply stated on the rating plate.
- The appliance has been used for normal domestic purposes only, and in accordance with the manufacturer's instructions.
- The appliance has not been serviced, maintained, repaired, taken apart or tampered with by any person not authorised by us.
- Electrolux Service Force Centre must undertake all service work under this guarantee.
- Any appliance or defective part replaced shall become the Company's property.
- This guarantee is in addition to your statutory and other legal rights.

Exclusions

- Damage or calls resulting from transportation, improper use or neglect, the replacement of any light bulbs or removable parts of glass or plastic.
- Costs incurred for calls to put right an appliance which is improperly installed or calls to appliances outside the United Kingdom.

- Appliances found to be in use within a commercial environment, plus those which are subject to rental agreements.
- Products of Electrolux manufacturer that are not marketed by Electrolux.

Service and Spare Parts

In the event of your appliance requiring service, or if you wish to purchase spare parts, please contact your local Service Force Centre by telephoning 0870 5 929 929

Your telephone call will be automatically routed to the Service Force Centre covering your postcode area. For the address of your local Service Force Centre and further information about Service Force, please visit the website at:

www.serviceforce.co.uk

Before calling out an engineer, please ensure you have read the details under the heading "Something not working"

When you contact the Service Force Centre you will need to give the following details:

1. Your name, address and postcode.
2. Your telephone number.
3. Clear concise details of the fault.
4. The model and Serial number of the appliance (found on the rating plate).
5. The purchase date.

Please note a valid purchase receipt or guarantee documentation is required for in guarantee service calls.

Customer Care

For general enquiries concerning your Electrolux appliance, or for further information on Electrolux products please contact our Customer Care Department by letter or telephone at the address below or visit our website at:

www.electrolux.co.uk

Customer Care Department Electrolux
Major Appliances

Addington Way

Luton

Bedfordshire, LU4 9QQ

Tel: 08705 950 950 (*)

() Calls may be recorded for training purposes*

For Customer Service in **The Republic of Ireland** please contact us at the address below:

Electrolux Group (Irl) Ltd

Long Mile Road, Dublin 12,

Republic of Ireland

Tel: + 353 (0)1 4090751

Email: service.eid@electrolux.ie

European Guarantee

This appliance is guaranteed by Electrolux in each of the countries listed at the back of this user manual, for the period specified in the appliance guarantee or otherwise by law.

If you move from one of these countries to another of the countries listed below the appliance guarantee will move with you subject to the following qualifications:



- The appliance guarantee starts from the date you first purchased the appliance which will be evidenced by production of a valid purchase document issued by the seller of the appliance.
- The appliance guarantee is for the same period and to the same extent for labour and parts as exists in your new country of residence for this particular model or range of appliances.
- The appliance guarantee is personal to the original purchaser of the appliance and cannot be transferred to another user.
- The appliance is installed and used in accordance with instructions issued by Electrolux and is only used within the home, i.e. is not used for commercial purposes.
- The appliance is installed in accordance with all relevant regulations in force within your new country of residence.

The provisions of this European Guarantee do not affect any of the rights granted to you by law.

Customer Service Centres

Should you need further assistance please contact your local Customer Service Centre

www.electrolux.com

		
Albania	+35 5 4 261 450	Rr. Pjeter Bogdani Nr. 7 Tirane
Belgique/België/Belgien	+32 2 363 04 44	Bergensesteenweg 719, 1502 Lembeek
Česká republika	+420 2 61 12 61 12	Budějovická 3, Praha 4, 140 21
Danmark	+45 70 11 74 00	Sjællandsgade 2, 7000 Fredericia
Deutschland	+49 180 32 26 622	Muggenhofer Str. 135, 90429 Nürnberg
Eesti	+37 2 66 50 030	Mustamäe tee 24, 10621 Tallinn
España	+34 902 11 63 88	Carretera M-300, Km. 29,900 Alcalá de Henares Madrid
France	www.electrolux.fr	
Great Britain	+44 8705 929 929	Addington Way, Luton, Bedfordshire LU4 9QQ
Hellas	+30 23 10 56 19 70	4, Limnou Str., 54627 Thessaloniki
Hrvatska	+38 51 63 23 338	Slavonska avenija 3, 10000 Zagreb
Ireland	+353 1 40 90 753	Longmile Road Dublin 12
Italia	+39 (0) 434 558500	C.so Lino Zanussi, 26 - 33080 Porcia (PN)
Latvija	+37 17 84 59 34	Kr. Barona iela 130/2, LV-1012, Riga
Lituania	+370 5 27 80 609	Verkių 2 9, 09108 Vilnius, Lithuania
Luxembourg	+35 2 42 43 13 01	Rue de Bitbourg, 7, L-1273 Hamm
Magyarország	+36 1 252 1773	H-1142 Budapest XIV, Erzsébet királyné útja 87
Nederland	+31 17 24 68 300	Vennootsweg 1, 2404 CG - Alphen aan den Rijn
Norge	+47 81 5 30 222	Risløkkvn. 2 , 0508 Oslo
Österreich	+43 18 66 400	Herziggasse 9, 1230 Wien
Polska	+48 22 43 47 300	ul. Kolejowa 5/7, Warsaw
Portugal	+35 12 14 40 39 39	Quinta da Fonte - Edifício Gonçalves Zarco - Q35 -2774-518 Paço de Arcos
Romania	+40 21 451 20 30	Str. Garii Progresului 2, S4, 040671 RO
Schweiz-Suisse-Svizzera	+41 62 88 99 111	Industriestrasse 10, CH-5506 Mägenwil
Slovenija	+38 61 24 25 731	Tr aška 132, 1000 Ljubljana
Slovensko	+421 2 43 33 43 22	Electrolux Slovakia s.r.o., Electrolux Domáce spotrebiče SK, Seberínho 1, 821 03 Bratislava
Suomi	www.electrolux.fi	
Sverige	+46 (0)771 76 76 76	Electrolux Service, S:t Göransgatan 143, S-105 45 Stockholm
Türkiye	+90 21 22 93 10 25	Tarlabası caddesi no : 35 Taksim Istanbul
Россия	+7 095 937 7837	129090 Москва, Олимпийский проспект, 16, БЦ "Олимпик"



www.electrolux.com



ANC number: 132 973 260 -01-192007